

Operating Instructions Air Conditioner

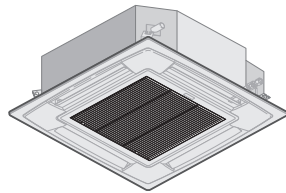

Ceiling (T2 type)



4-Way Cassette (U1 type)

Model No.

INDOOR UNIT

Ceiling (T2 type)

S-60PT2R5
S-71PT2R5
S-100PT2R5
S-125PT2R5
S-140PT2R5

4-Way Cassette (U1 type)

S-60PU1R5
S-71PU1R5
S-100PU1R5
S-125PU1R5
S-140PU1R5

OUTDOOR UNIT

Single Split (Single-phase)

U-60PE1R5
U-71PE1R5
U-100PE1R5
U-125PE1R5
U-140PE1R5

Single Split (3-phase)

U-100PE1R8
U-125PE1R8
U-140PE1R8



Before operating the unit, read these operating instructions thoroughly and keep them for future reference.

Thank you for purchasing this Panasonic product.
 This product is a commercial air conditioner indoor unit.
 Installation Instructions attached.

Contents

- **Safety Precautions** 2
- **Precautions for Use** 4
- **Names of Parts** 5
 - **Operation Mechanism** 5

- **Adjusting Airflow Direction** 6
 - **Adjusting airflow direction for multiple indoor units** 7

- **Maintenance** 8
 - **Before Requesting Services** 8
- **Troubleshooting** 9

- **Specifications** 10
 - **Indoor unit** 10
 - **Outdoor unit** 11

Product Information

If you have problems or questions concerning your Air Conditioner, you will need the following information. Model and serial numbers are on the nameplate on the bottom of the cabinet.

Model No.	
Serial No.	
Date of purchase	
Dealer's address	
Phone number	

Safety Precautions

The following symbols used in this manual, alert you to potentially dangerous conditions to users, service personnel or the appliance:

	WARNING This symbol refers to a hazard or unsafe practice which can result in severe personal injury or death.
	CAUTION This symbol refers to a hazard or unsafe practice which can result in personal injury or product or property damage.
	Prohibited matters
	Matters to be observed

! WARNING

Confirm to authorized dealer or specialist on usage of specified refrigerant type. Using of refrigerant other than the specified type may cause product damage, burst and injury etc.

This air conditioner has no ventilator for intaking fresh air from outdoors. You must open doors or windows frequently when you use gas or oil heating appliances in the same room, which consume a lot of oxygen from the air. Otherwise there is a risk of suffocation in an extreme case.

Never use or store gasoline or other flammable vapor or liquid near the air conditioner — it is very dangerous.

Do not use this appliance in a potentially explosive atmosphere.

Never touch the unit with wet hands.

Do not insert your fingers or other objects into the air conditioner indoor or outdoor unit, rotating parts may cause injury.

Refrigerant gas leakage may cause fire.

For safety, be sure to turn the air conditioner off and also to disconnect the power before cleaning or servicing.

Pull off the power plug from a receptacle, or switch off the breaker, or switch off the power disconnecting mean to isolate the air conditioner from the main power supply in case of emergency.

Do not clean inside the indoor and outdoor units by users. Engage authorized dealer or specialist for cleaning.

In case of malfunction of this appliance, do not repair by yourself. Contact to the sales dealer or service dealer for a repair.

- Read these Operating Instructions carefully before using this air conditioner. If you still have any difficulties or problems, consult your dealer for help.
- This air conditioner is designed to give you comfortable room conditions. Use this only for its intended purpose as described in these Operating Instructions.

CAUTION



This appliance is intended to be used by expert or trained users in shops, in light industry and on farms, or for commercial use by lay persons.

This appliance is not intended for use by persons (including children) with reduced physical, sensory or mental capabilities, or lack of experience and knowledge, unless they have been given supervision or instruction concerning use of the appliance by a person responsible for their safety. Children should be supervised to ensure that do not play with the appliance.

Keep the fire alarm and the air outlet at least 1.5m away from the unit.

Do not cool or heat the room too much if babies or invalids are present.



Do not turn the air conditioner on and off from the power mains switch. Use the ON/OFF operation button.

Do not stick anything into the air outlet of the outdoor unit. This is dangerous because the fan is rotating at high speed.



Do not touch the air inlet or the sharp aluminum fins of the outdoor unit. You may get injured.



Do not sit or step on the unit. You may fall down accidentally.



Do not stick any object into the FAN CASE. You may be injured and the unit may be damaged.



Provide a power outlet to be used exclusively for each unit, and a power supply disconnect, circuit breaker and earth leakage breaker for overcurrent protection should be provided in the exclusive line.

Provide a power outlet exclusively for each unit, and full disconnection means having a contact separation in all poles must be incorporated in the fixed wiring in accordance with the wiring rules.

To prevent possible hazards from insulation failure, the unit must be grounded.



Do not use modified cord, joint cord, extension cord or unspecified cord to prevent overheating and fire.



Stop using the product when any abnormality/failure occurs and disconnect the power plug or turn off the power switch and breaker.

(Risk of smoke/fire/electric shock)

Examples of abnormality/failure

- The ELCB trips frequently.
- The product sometimes does not start when turned on.
- The power is sometimes disconnected when the cord is moved.
- Burnt odor or abnormal noise is detected during operation.
- The body is deformed or abnormally hot.
- Water leaks from the indoor unit.
- Power cord or plug becomes abnormally hot.
- Fan speed cannot be controlled.
- The unit stops running immediately even if it is switched on for operation.
- The fan does not stop even if the operation is stopped.

Contact immediately your local dealer for maintenance/repair.

NOTICE

- The compressor may occasionally stop during thunderstorms. This is not a mechanical failure. The unit automatically recovers after a few minutes.

Important Information Regarding The Refrigerant Used

This product contains fluorinated greenhouse gases covered by the Kyoto Protocol. Do not vent gases into the atmosphere.

Refrigerant type: R410A

GWP⁽¹⁾ value: 1975

⁽¹⁾ GWP = global warming potential

Periodical inspections for refrigerant leaks may be required depending on European or local legislation. Please contact your local dealer for more information.

Precautions for Use

Installation

- This air conditioner must be installed properly by qualified installation technicians in accordance with the Installation Instructions provided with the unit.
- Before installation, check that the voltage of the electric supply in your home or office is the same as the voltage shown on the nameplate.

WARNING

Avoid the following locations for installation.

- Locations where smoke or combustible gas exists.
Also locations of extremely high temperature such as a greenhouse.
- Locations where excessively high heat-generating objects are placed.

Attention:

- Avoid installing the outdoor unit where salty sea water can splash directly onto it or in sulphurous air near a spa.
(To protect the air conditioner from heavy corrosion)

Wiring

- All wiring must conform to the local electrical codes.
(Consult your dealer or a qualified electrician for details.)
- Each unit must be properly grounded with a ground (or earth) wire or through the supply wiring.
- Wiring must be done by a qualified electrician.

Operation Preparation

Turn the power mains on 5 hours before the start of operation.

(For warm-up)

- Leave the power mains ON for continuous use.

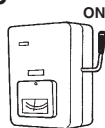

NOTE

Pull off the power plug from a receptacle, or switch off the breaker, or switch off the power disconnecting mean to isolate the air conditioner from the main power supply when not in use for a long time.

Operation Condition

Use this air conditioner under the following temperature range.

■ Indoor temperature range:

Cooling mode 14°C ~ 25°C (*WBT) / 18°C ~ 32°C (*DBT)

Heating mode 16°C ~ 30°C (*DBT)

■ Outdoor temperature range:

Cooling mode -15°C ~ 46°C (*DBT)

Heating mode -20°C ~ 18°C (*WBT) / -20°C ~ 24°C (*DBT)

*DBT: Dry bulb temperature

*WBT: Wet bulb temperature

Information for Users on Collection and Disposal of Old Equipment and Used Batteries



[Information on Disposal in other Countries outside the European Union]

These symbols are only valid in the European Union. If you wish to discard these items, please contact your local authorities or dealer and ask for the correct method of disposal.



Note for the battery symbol (bottom two symbol examples):

This symbol might be used in combination with a chemical symbol. In this case it complies with the requirement set by the Directive for the chemical involved.



Names of Parts

INDOOR UNIT

OUTDOOR UNIT

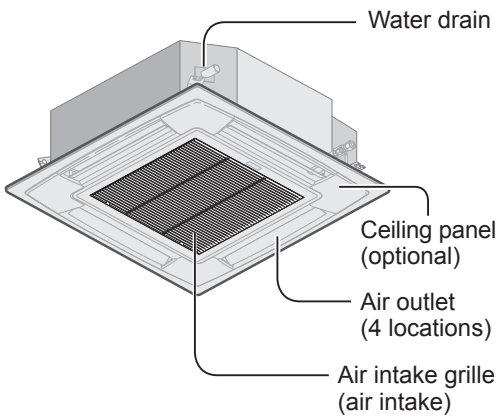

U1 type (4-Way Cassette)

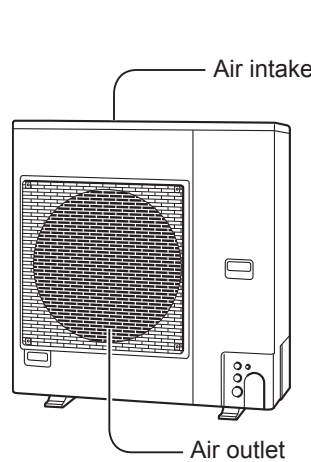

60, 71 type

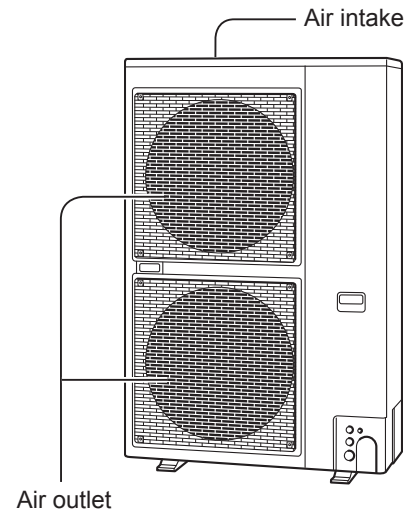

100, 125, 140 type

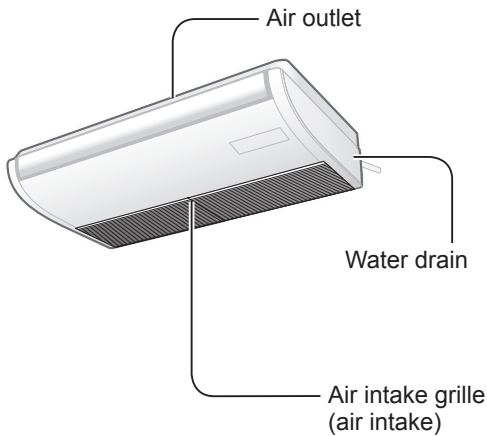

T2 type (Ceiling)

Optional

Wireless Remote Controller



For all indoor units

Timer Remote Controller



For all indoor units

Read the operating instructions included with the Remote Controller.

Operation Mechanism

■ Heating performance

- Since this air conditioner utilizes outside air for heating, its heating performance deteriorates as outside temperature decreases.
(Due to heat pump system)
→ In that case, use another heating appliance.

■ Defrosting

- This appliance may start defrosting operation to melt frost formed in the outdoor unit.
 - ① **Defrosting starts:** The indoor unit fan stops (or the speed becomes extremely slow).
→ "STANDBY" appears.
 - ② **Heating operation resumes after several minutes:** The indoor unit fan remains stopped (or it will run at a very slow speed) until the indoor heat exchanger coil warms up sufficiently.
→ "STANDBY" is shown.
 - ③ **Defrosting is complete:** The indoor unit fan starts operation.
→ "STANDBY" disappears.

■ "DRY" operation

- Once the room temperature reaches the level that was set, the outdoor unit repeats the cycle of turning on and off automatically.
- When the outdoor unit is turned off, the indoor unit fan will stop, too.
(To prevent the humidity in the room from rising again)
- When the room temperature is more likely to reach the level that was set, the fan speed is set to "breeze" (light wind) automatically.
- "DRY" operation is not possible if the outdoor temperature is 15 °C or less.

■ Should the power failure occurs while the unit is running

When the unit automatically resumes operation after temporary power failure, it uses the same settings before the power was cut off.

Adjusting Airflow Direction



Adjusting the upward and downward motion of airflow direction (U1 and T2 types)

■ Using the timer remote controller

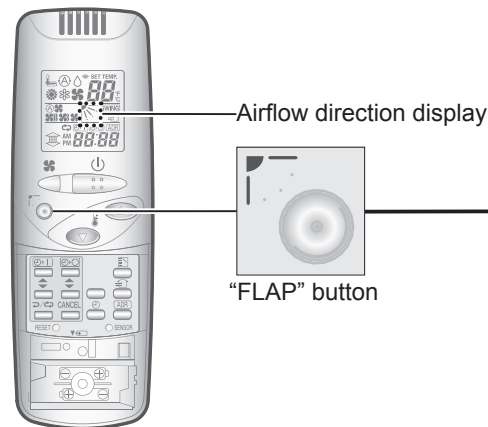

■ Using the wireless remote controller



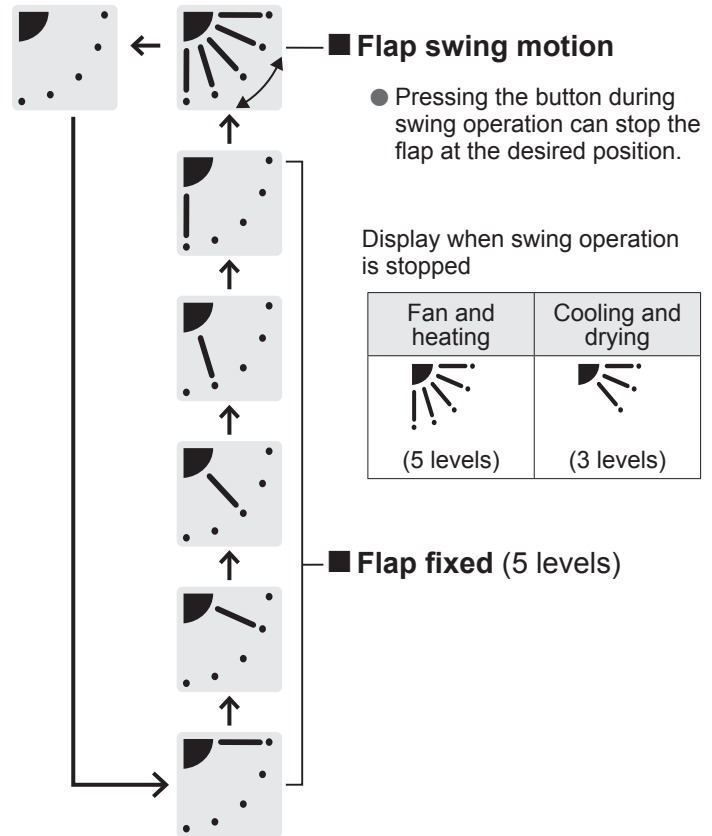

Press  /  to select your desired airflow direction.



Recommended vertical airflow direction

- Set the flap to the downward position for heating operation. (With the upward setting, warm air cannot reach the floor.)
- Set the flap to the upward position for cooling operation. (With the downward setting, condensation may drip on to the floor.)

U1, T2 type

HEAT	COOL / DRY	FAN
		
Recommended	Recommended	Fixed to this position

■ Adjusting the horizontal airflow direction (Manual: T2 type only)

Move the horizontal airflow vanes by hand for adjustment.

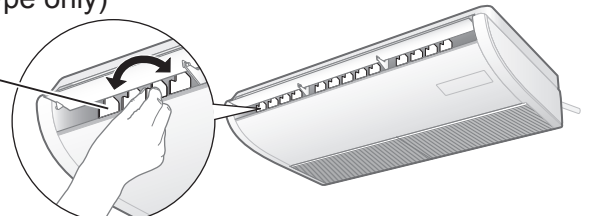

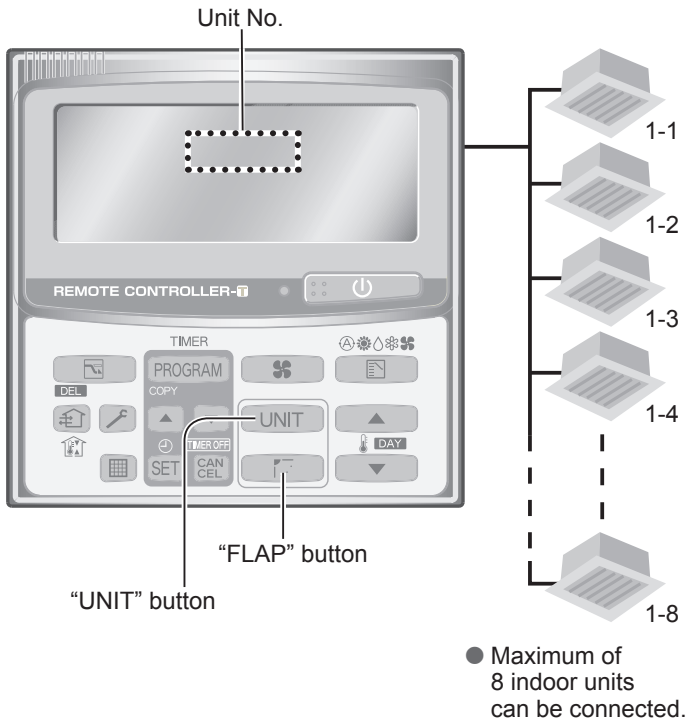

Adjusting airflow direction for multiple indoor units (Timer remote controller only)

When operating multiple indoor units using 1 remote controller, airflow direction can be adjusted for indoor each unit individually or all units at the same time.

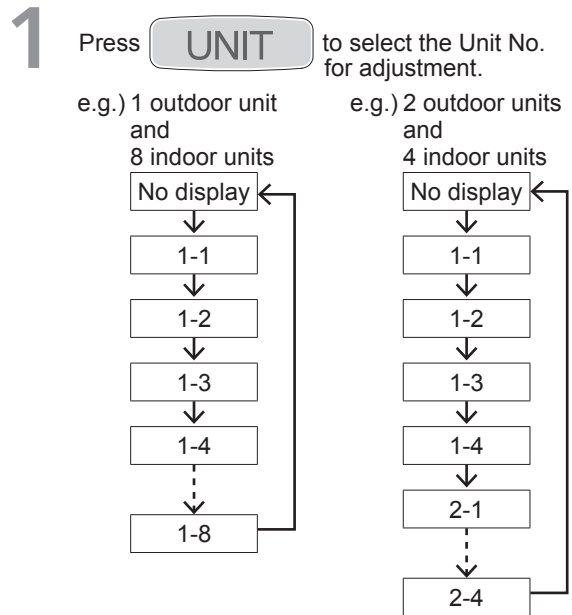

■ When setting the airflow direction of each indoor unit individually



2 Press  to select your desired airflow direction.

■ When setting the airflow direction of all indoor units at the same time

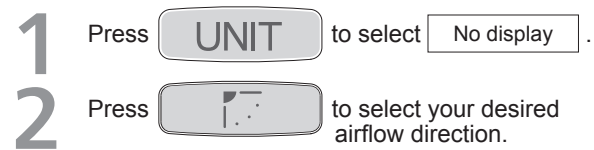

Attention:

- Never use your hands to move the flap (vertical airflow flap) controlled using the remote controller.

Note

- When the air conditioner is turned off, the flap (vertical airflow flap) automatically moves to the downward position.
- The flap (vertical airflow flap) moves to the upward position during standby operation for heating.
- The swing operation starts after the standby operation has finished, but “Swing” is indicated on the remote controller even during the standby operation.

Tips for Energy Saving

■ Avoid

- Do not block the air intake and outlet of the unit. (If either is obstructed, the unit will not function well, causing malfunction.)
- During cooling operation, use sunshades, blinds or curtains to prevent direct sunlight from entering the room.

■ Do

- Always keep the air filter clean. (A clogged filter will impair the performance of the unit.) → “Maintenance” (P.8)
- To prevent conditioned air from escaping, keep windows, doors and any other openings closed.

Maintenance

Indoor unit (e.g. U1 type)

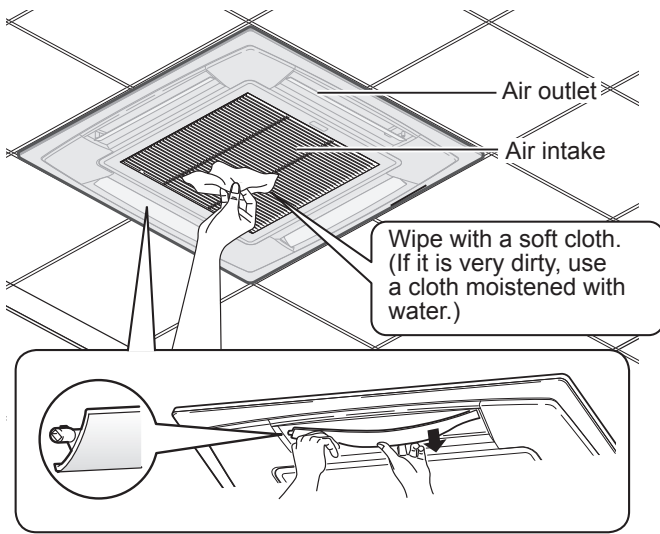

Wash the flap for the air outlet with water.

(U1 type only)

- Be sure to stop the operation beforehand.
- After washing with water, allow it to dry, and then attach it with the arrow facing outward.

⚠ WARNING

- For safety, be sure to turn the air conditioner off and disconnect the power before cleaning. (Otherwise, electric shock or injury may result because the fan is rotating at high speed.)
- Do not pour water on the indoor unit. (This may damage the internal components and cause an electric shock hazard.)

⚠ CAUTION

- Never use solvents or harsh chemicals. Also, do not wipe plastic parts using very hot water. (This may cause deformation or change in colour.)
- Some metal edges and fins are sharp. Be careful when you clean those parts. (Injury may result.)
- Use a firm stool or ladder when cleaning an indoor unit installed in high locations.
- The internal coil and other components of the outdoor unit must be cleaned periodically.
 - Consult your dealer or service center.

Before Requesting Services

Symptom	Cause	Action
The air conditioner does not operate although the power is turned on.	Power failure or after power failure	Press the power ON/OFF button on the remote controller.
	The operation (power) button is turned off.	<ul style="list-style-type: none"> • If the breaker is turned off, turn the power on. • If the breaker has been tripped, consult your dealer without turning it on.
	Fuse blow out.	Contact your dealer.
Poor cooling or heating performance	The air intake or air outlet of indoor and outdoor units is clogged with dust.	Remove the dust.
	The wind speed switch is set to "Low".	Change to "High" or "Strong".
	Improper temperature settings	See "Tips for Energy Saving". (P.7)
	The room is exposed to direct sunlight in cooling mode.	
	Doors or windows are open.	See "Maintenance". (P.8)
	The air filter is clogged.	
	Too many heat sources in the room in cooling mode.	Use minimum heat sources and in a short time.
Too many people in the room in cooling mode.	Lower the temperature setting or change to "High" or "Strong".	

If your air conditioner does not work properly even after checking each item of "Before Requesting Services" and "Troubleshooting"

- Stop the operation immediately and turn the power off. Then contact your dealer and report the serial number and symptom. You also report if the inspection mark # and the letters E, F, H, L, P in combination with numbers appear on the LCD of the remote controller.
- Never repair the air conditioner by yourself since it is very dangerous for you to do so.

Troubleshooting

Check before consulting or requesting services.

		Symptom	Cause / Action
Indoor unit	Noise	Sound like streaming water is heard during operation or after operation.	<ul style="list-style-type: none"> • Sound of refrigerant liquid flowing inside unit • Sound of drainage water through drain pipe
		Cracking noise is heard during operation or when operation stops.	Sound due to temperature changes of parts
	Discharged air smells during operation.		<ul style="list-style-type: none"> • Indoor odor components, cigarette odor and cosmetic odor accumulated in the air conditioner and its air is discharged. • The unit inside is dirty. (Contact your dealer.)
	Dewdrops accumulate near the air outlet during cooling operation.		<ul style="list-style-type: none"> • Internal moisture is cooled by cool wind and accumulates as dewdrops.
	Fog occurs during cooling operation.		<ul style="list-style-type: none"> • If the air conditioner has been installed at places such as restaurants where large amounts of oil mist exist, cleaning is necessary because the unit inside (heat exchanger) is dirty. (Contact your dealer.)
	Fog occurs during heating operation.		<ul style="list-style-type: none"> • Defrost operation is in process.
	The fan is rotating for a while even though operation stops.		<ul style="list-style-type: none"> • Fan rotation makes operation smooth. • The fan may rotate to dry the heat exchanger depending on the setting.
	Airflow direction	Airflow direction changes while operating. Airflow direction cannot be set. Airflow direction cannot be changed.	<ul style="list-style-type: none"> • When air discharge temperature is low during heating operation, or during defrost operation, horizontal wind flow is made automatically. • The flap position may be set individually. (U1 type)
		The flap moves several times after the direction is changed.	<ul style="list-style-type: none"> • The flap moves to the standard position once, and then turns to the set airflow direction.
	Dust is discharged.		<ul style="list-style-type: none"> • Dust accumulated inside the indoor unit is discharged.
	At the initial high-speed operation, the fan sometimes rotates faster than the setting speed. (3 to 30 minutes)		<ul style="list-style-type: none"> • This is for operation check in order to confirm whether the fan motor rotation is within the range of use.
Outdoor unit	No operation (When the power is turned on immediately / When operation is stopped and resumed immediately)		<ul style="list-style-type: none"> • Operation is not activated for the first approx. 3 minutes because the compressor protection circuit is activated.
	Noise occurs during heating operation.		<ul style="list-style-type: none"> • Defrost operation is in process.
	Steam comes out during heating operation.		
	The fan continues to rotate even after the operation is stopped using the remote controller.		<ul style="list-style-type: none"> • This is for smooth operation.

Specifications

Indoor unit

4-Way Cassette (U1 type)

Model Name			S-60PU1R5	S-71PU1R5	S-100PU1R5	S-125PU1R5	S-140PU1R5
Power source			230/240 V~ 50 Hz				
Cooling capacity	kW		6.0	7.1	10.0	12.5	14.0
	BTU/h		20,500	24,200	34,100	42,700	47,800
Heating capacity	kW		7.0	8.0	11.2	14.0	16.0
	BTU/h		23,900	27,300	38,200	47,800	54,600
Sound pressure level	High	dB(A)	36	37	44	45	46
	Medium	dB(A)	31	31	38	39	40
	Low	dB(A)	28	28	32	33	34
Sound power level	High	dB(A)	53	54	62	63	64
	Medium	dB(A)	48	48	55	56	57
	Low	dB(A)	45	45	49	50	51
Unit dimensions (H×W×D)		mm	290×950×950	290×950×950	353×950×950	353×950×950	353×950×950
Net weight		kg	28	28	31	31	31

Ceiling (T2 type)

Model Name			S-60PT2R5	S-71PT2R5	S-100PT2R5	S-125PT2R5	S-140PT2R5
Power source			230/240 V~ 50 Hz				
Cooling capacity	kW		6.0	7.1	10.0	12.5	14.0
	BTU/h		20,500	24,200	34,100	42,700	47,800
Heating capacity	kW		7.0	8.0	11.2	14.0	16.0
	BTU/h		23,900	27,300	38,200	47,800	54,600
Sound pressure level	High	dB(A)	38	39	42	46	47
	Medium	dB(A)	34	35	37	40	41
	Low	dB(A)	30	31	35	36	37
Sound power level	High	dB(A)	56	57	60	64	65
	Medium	dB(A)	52	53	55	58	59
	Low	dB(A)	48	49	53	54	55
Unit dimensions (H×W×D)		mm	235×1,275×690	235×1,275×690	235×1,590×690	235×1,590×690	235×1,590×690
Net weight		kg	33	33	40	40	40

Outdoor unit

Single Split Outdoor Unit

Model Name		U-60PE1R5	U-71PE1R5	U-100PE1R5	U-125PE1R5	U-140PE1R5
Power source		230/240 V ~ 50 Hz				
Cooling capacity	kW	6.0	7.1	10.0	12.5	14.0
	BTU/h	20,500	24,200	34,100	42,700	47,800
Heating capacity	kW	7.0	8.0	11.2	14.0	16.0
	BTU/h	23,900	27,300	38,200	47,800	54,600
Sound pressure level (C/H)	dB(A)	48 / 50	48 / 50	52 / 52	53 / 53	54 / 55
Sound power level (C/H)	dB(A)	65 / 67	65 / 67	69 / 69	70 / 70	71 / 71
Unit dimensions (H×W×D)	mm	996×940×340	996×940×340	1,416×940×340	1,416×940×340	1,416×940×340
Net weight	kg	68	69	98	98	98

Model Name		U-100PE1R8	U-125PE1R8	U-140PE1R8
Power source		400/415 V 3N ~ 50 Hz		
Cooling capacity	kW	10.0	12.5	14.0
	BTU/h	34,100	42,700	47,800
Heating capacity	kW	11.2	14.0	16.0
	BTU/h	38,200	47,800	54,600
Sound pressure level (C/H)	dB(A)	52 / 52	53 / 53	54 / 55
Sound power level (C/H)	dB(A)	69 / 69	70 / 70	71 / 71
Unit dimensions (H×W×D)	mm	1,416×940×340	1,416×940×340	1,416×940×340
Net weight	kg	98	98	98

Panasonic Corporation
Website: <http://panasonic.net/>

© Panasonic Corporation 2013

Printed in China

F569022
DC0413-10613